

D10040220GT

GaAs Power Doubler Hybrid
40MHz to 1000MHz

The D10040220GT is a Hybrid Power Doubler amplifier module. The part employs GaAs die and is operated from 40MHz to 1000MHz. It provides excellent linearity and superior return loss performance with low noise and optimal reliability.

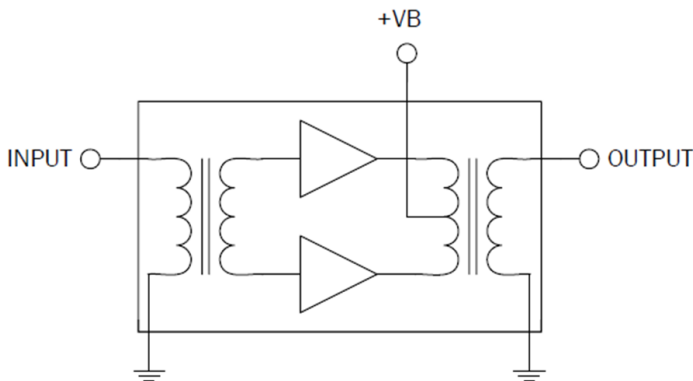

Package: SOT-115J

Features

- Excellent Linearity
- Superior Return Loss Performance
- Extremely Low Distortion
- Optimal Reliability
- Low Noise
- Unconditionally Stable Under All Terminations
- 22.5dB Min. Gain at 1GHz
- 375mA Max. at 24VDC

Applications

- 40MHz to 1000MHz CATV Amplifier Systems

Ordering Information

D10040220GT Box with 50 pieces

Absolute Maximum Ratings

Parameter	Rating	Unit
RF Input Voltage (single tone)	75	dBmV
DC Supply Over-Voltage (5 minutes)	30	V
Storage Temperature	-40 to +100	°C
Operating Mounting Base Temperature	-30 to +100	°C



Caution! ESD sensitive device.



RoHS (Restriction of Hazardous Substances): Compliant per EU Directive 2011/65/EU.

Exceeding any one or a combination of the Absolute Maximum Rating conditions may cause permanent damage to the device. Extended application of Absolute Maximum Rating conditions to the device may reduce device reliability. Specified typical performance or functional operation of the device under Absolute Maximum Rating conditions is not implied.

Nominal Operating Parameters

Parameter	Specification			Unit	Condition
	Min	Typ	Max		
General Performance					V+ = 24V; T_{MB} = 30°C; Z_S = Z_L = 75Ω
Power Gain	21.0	21.5	22.0	dB	f = 50MHz
	22.5	23.0	24.0	dB	f = 1000MHz
Slope ^[1]	1.0	1.5	2.5	dB	f = 40MHz to 1000MHz
Flatness of Frequency Response			0.8	dB	f = 40MHz to 1000MHz (Peak to Valley)
Input Return Loss	20.0			dB	f = 40MHz to 320MHz
	19.0			dB	f = 320MHz to 640MHz
	17.0			dB	f = 640MHz to 870MHz
	16.0			dB	f = 870MHz to 1000MHz
Output Return Loss	20.0			dB	f = 40MHz to 320MHz
	19.0			dB	f = 320MHz to 640MHz
	18.0			dB	f = 640MHz to 870MHz
	17.0			dB	f = 870MHz to 1000MHz
Noise Figure		5.5	6.5	dB	f = 50MHz to 1000MHz
Total Current Consumption (DC)		350.0	375.0	mA	
Distortion Data 40MHz to 870MHz					V+ = 24V; T_{MB} = 30°C; Z_S = Z_L = 75Ω
CTB		-64	-62	dBc	132 ch flat; V ₀ = 44dBmV ^[2]
XMOD		-60	-58	dBc	
CSO		-65	-63	dBc	

1. The slope is defined as the difference between the gain at the start frequency and the gain at the stop frequency.

2. 132 channels, NTSC frequency raster: 55.25MHz to 865.25MHz, +44dBmV flat output level.

Composite Second Order (CSO) - The CSO parameter (both sum and difference products) is defined by the NCTA.

Composite Triple Beat (CTB) - The CTB parameter is defined by the NCTA.

Cross Modulation (XMOD) - Cross modulation (XMOD) is measured at baseband (selective voltmeter method), referenced to 100% modulation of the carrier being tested.

Package Drawing (Dimensions in millimeters)

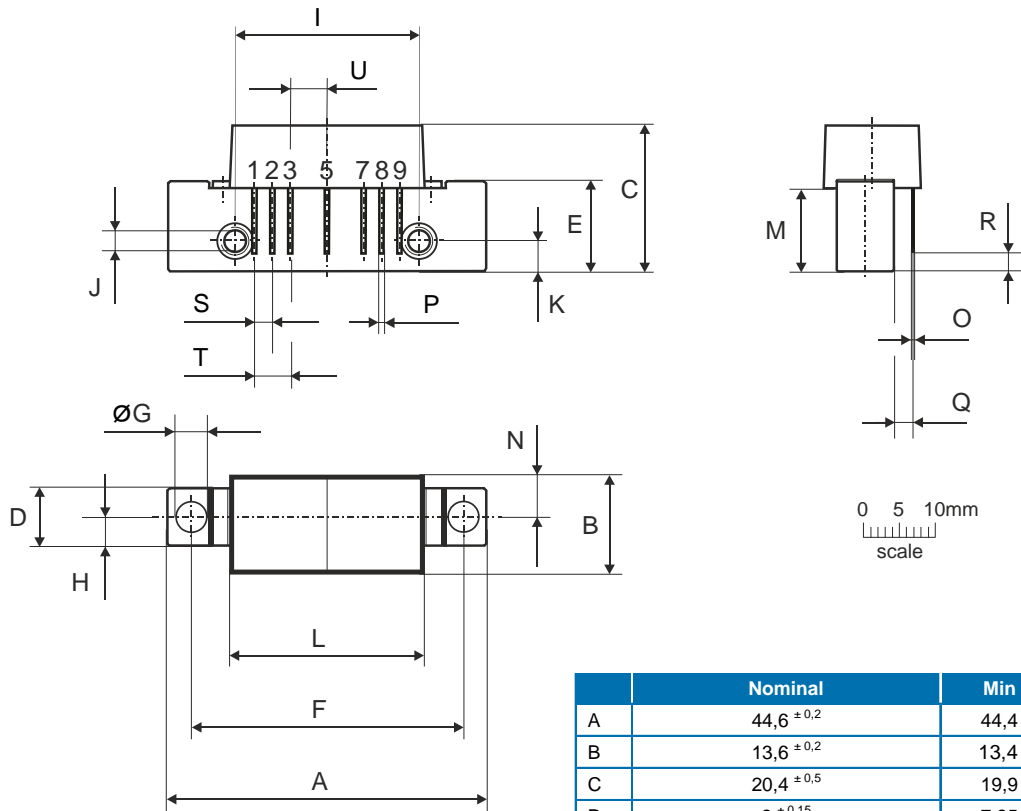

Notes:

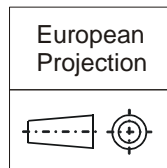

Pinning:

Pin	Name
1	Input
2-3	GND
4	
5	+VB
6	
7-8	GND
9	Output

	Nominal	Min	Max
A	44,6 ±0,2	44,4	44,8
B	13,6 ±0,2	13,4	13,8
C	20,4 ±0,5	19,9	20,9
D	8 ±0,15	7,85	8,15
E	12,6 ±0,15	12,45	12,75
F	38,1 ±0,2	37,9	38,3
G	4 ^{+0,2/-0,05}	3,95	4,2
H	4 ±0,2	3,8	4,2
I	25,4 ±0,2	25,2	25,6
J	UNC 6-32	-	-
K	4,2 ±0,2	4,0	4,4
L	27,2 ±0,2	27,0	27,4
M	11,6 ±0,5	11,1	12,1
N	5,8 ±0,4	5,4	6,2
O	0,25 ±0,02	0,23	0,27
P	0,45 ±0,03	0,42	0,48
Q	2,54 ±0,3	2,24	2,84
R	2,54 ±0,5	2,04	3,04
S	2,54 ±0,25	2,29	2,79
T	5,08 ±0,25	4,83	5,33
U	5,08 ±0,25	4,83	5,33